

NOTES:

1.MATERIALS:

1-1.HOUSING: SEE TABLE ,GLASS FIBER FILLED UL94V-0, COLOR: SEE TABLE.

1-2.CONTACT: SEE TABLE

2.PLATING:

2-1.CONTACT AREA: GOLD, THICKNESS : SEE TABLE .

2-2.SOLDER TAIL: 100 MICRINCH MIN. TIN PLATING.

2-3.UNDER PLATING: NICKEL PLATING OVERALL.

3.WEEK CODE: XX(YEAR) XX(WEEK) X(LOCATION).

4.PRODUCT SPECIFICATION REFER TO PS-87715-200.

5.PACKAGING SPECIFICATION REFER TO PK-87715-207.

6.TEST SUMMARY:REFER TO TS-87715-207.

7.LEAD FREE AND ROHS COMPLIANCE PRODUCT.

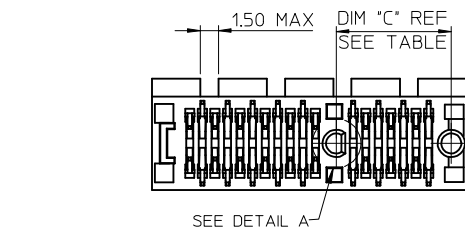
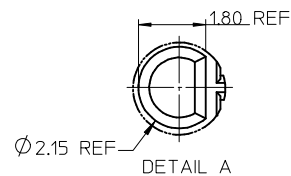
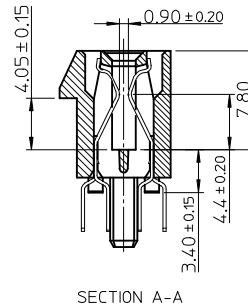
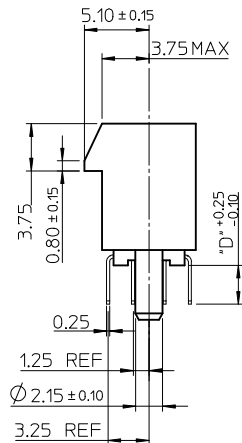
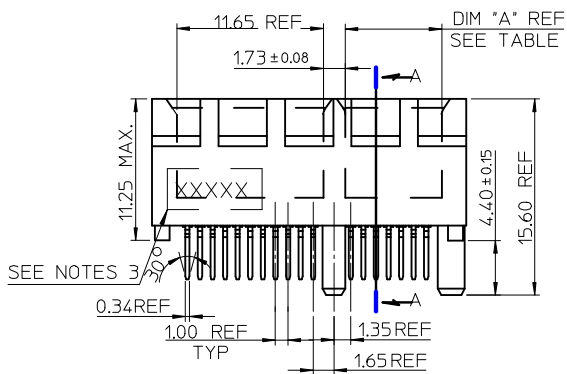

CONNECTOR LINK WIDTH	# POS REF	N	DIM 'A'	DIM 'B'	DIM 'C'	PCB THK (REF)	DIM 'D'
X1	36	6	7.65	25.00	9.15	1.60	2.30
X4	64	20	21.65	39.00	23.15	1.58	2.54
X8	98	37	38.65	56.00	40.15	2.36	3.00
X16	164	70	71.65	89.00	73.15		

PCB THK (REF)	DIM 'D'
1.60	2.30
1.58	2.54
2.36	3.00

CORRECT P/N	EC NO: SH2009-0199	2008/10/13	2008/11/03
	DRWN:GWANG08	2008/10/13	
	CHKD:DMZHANG02	2008/10/17	
	APPR:HMWANG	2008/11/03	
REV	DESCRIPTION		

QUALITY SYMBOLS	▽=0
	∇=0
GENERAL TOLERANCES (UNLESS SPECIFIED)	
	mm INCH
4 PLACES	± --- ± ---
3 PLACES	± --- ± ---
2 PLACES	± 0.25 ± ---
1 PLACE	± 0.25 ± ---
	ANGULAR ± 3 °
DRAFT WHERE APPLICABLE MUST REMAIN WITHIN DIMENSIONS	

DIMENSION STYLE		SCALE	DESIGN UNITS	THIRD ANGLE PROJECTION
MM ONLY			METRIC	
DRAWN BY	DATE	TITLE		
TOM	2004/07/20	PCI EXPRESS		
CHECKED BY	DATE	EDGE CARD CONNECTOR		
ALLEN LIN	2004/07/20	(LEAD FREE VERSION)		
APPROVED BY	DATE	MOLEX INCORPORATED		
WILSON	2004/07/20	MOLEX INCORPORATED		
MATERIAL NO.	DOCUMENT NO.	SHEET NO.		
SEE TABLE	SD-87715-207	1 OF 11		

THIS DRAWING CONTAINS INFORMATION THAT IS PROPRIETARY TO MOLEX INCORPORATED AND SHOULD NOT BE USED WITHOUT WRITTEN PERMISSION	
---	--

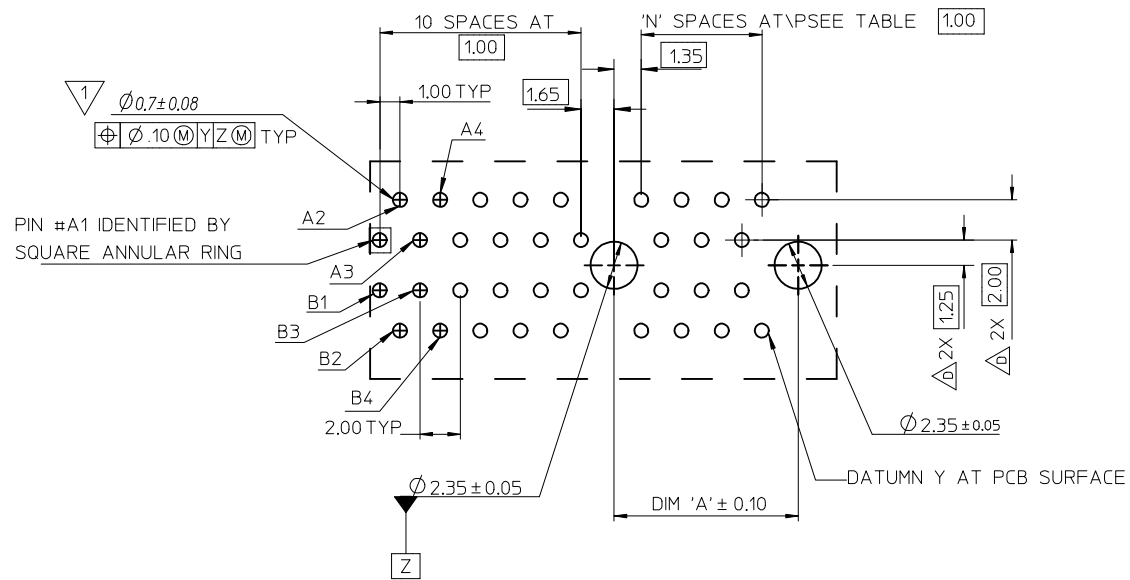

1 THE HORIZONTAL AXIS FOR THE HOLE PATTERN IS ESTABLISHED BY A LINE THROUGH THE CENTER OF THE TWO Ø2.35 HOLES. THE VERTICAL AXIS IS 90° TO THE HORIZONTAL AXIS. THROUGH THE CENTER OF DATUM Z

PIN #A1 IDENTIFIED BY SQUARE ANNULAR RING

CONNECTOR LINK WIDTH	# POS REF	N	DIM 'A'
X1	36	6	9.15
X4	64	20	23.15
X8	98	37	40.15
X16	164	70	73.15

SEE SHEET 1 EC NO: SH2009-0199 DRWN: GWANG08 CHK'D: DMZHANG02 APPR: HWANG	2008/10/13 2008/10/17 2008/11/03	DESCRIPTION REV	QUALITY SYMBOLS	GENERAL TOLERANCES (UNLESS SPECIFIED)	DIMENSION STYLE	SCALE	DESIGN UNITS	THIRD ANGLE PROJECTION		
			▽=0 ▽=0	mm INCH 4 PLACES ± --- ± --- 3 PLACES ± --- ± --- 2 PLACES ± 0.25 ± --- 1 PLACE ± 0.25 ± --- ANGULAR ± 3°	MM ONLY		METRIC			
					DRAWN BY	DATE	TITLE			
					CHECKED BY	DATE	PCI EXPRESS EDGE CARD CONNECTOR (LEAD FREE VERSION)			
				APPROVED BY	DATE	MOLEX INCORPORATED				
				MATERIAL NO.		DOCUMENT NO.		SHEET NO.		
				SEE TABLE		SD-87715-207		2 OF 11		
				DRAFT WHERE APPLICABLE MUST REMAIN WITHIN DIMENSIONS						
				THIS DRAWING CONTAINS INFORMATION THAT IS PROPRIETARY TO MOLEX INCORPORATED AND SHOULD NOT BE USED WITHOUT WRITTEN PERMISSION						

10 9 8 7 6 5 4 3 2 1

F

E

D

C

B

A

F

E

D

C

B

A

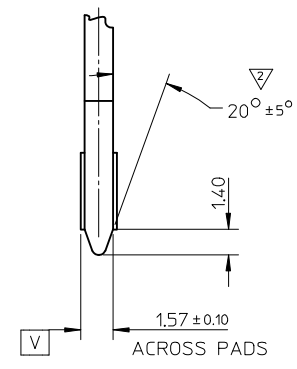
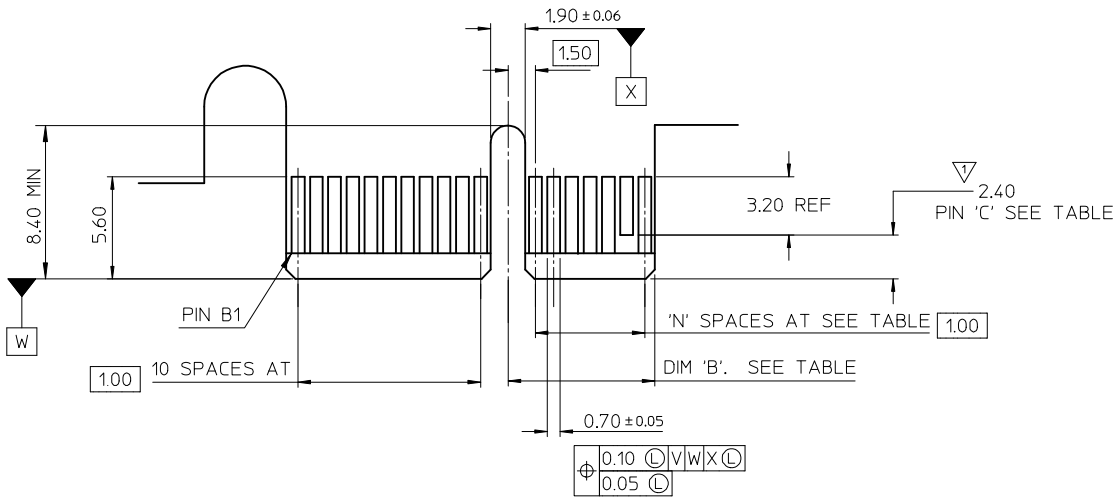

← I/O PANEL DIRECTION

PRIMARY (COMPONENT) SIDE

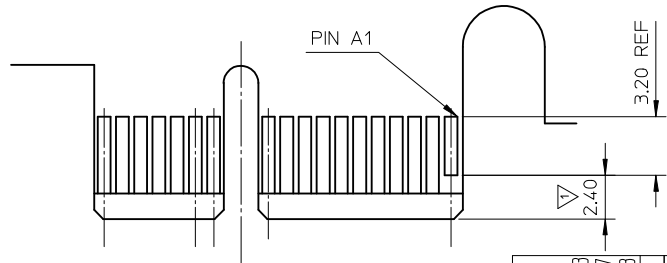

I/O PANEL DIRECTION →

SECONDARY (SOLDER) SIDE

- 1 NO TIE BAR PERMITTED FROM CARD EDGE TO LEADING EDGE OF PAD FOR PINS A1 AND "C".
- 2 CHAMFER EDGES MUST BE FREE OF CUTTING BURRS.
- 3. TOLERANCE: .XX±.13

CONNECTOR LINK WIDTH	# POS REF	N	DIM 'B'	'C'
X1	36	6	8.15	B17
X4	64	20	22.15	B17, B31
X8	98	37	39.15	B17, B31 B48
X16	164	70	72.15	B17, B31 B48, B81

SEE SHEET 1 EC NO: SH2009-0199 DRWING: GWANG08 CHK'D: DMZHANG02 APPR: HWANG 2008/10/13 2008/10/17 2008/11/03	QUALITY SYMBOLS	GENERAL TOLERANCES (UNLESS SPECIFIED)		DIMENSION STYLE		SCALE	DESIGN UNITS	THIRD ANGLE PROJECTION		
	=0			MM ONLY			METRIC			
	=0			mm	INCH	DRAWN BY	DATE	TITLE		
		4 PLACES	± ---	± ---		TOM	2004/07/20	PCI EXPRESS EDGE CARD CONNECTOR (LEAD FREE VERSION)		
	3 PLACES	± ---	± ---		CHECKED BY	DATE	MOLEX INCORPORATED			
	2 PLACES	± 0.25	± ---		ALLEN LIN	2004/07/20				
	1 PLACE	± 0.25	± ---		APPROVED BY	DATE	DOCUMENT NO. SD-87715-207			
					WILSON	2004/07/20				
		ANGULAR ± 3 °			MATERIAL NO.		SHEET NO. 3 OF 11			
		DRAFT WHERE APPLICABLE MUST REMAIN WITHIN DIMENSIONS			SIZE	THIS DRAWING CONTAINS INFORMATION THAT IS PROPRIETARY TO MOLEX INCORPORATED AND SHOULD NOT BE USED WITHOUT WRITTEN PERMISSION				
					A3					



9 8 7 6 5 4 3 2 1

10 9 8 7 6 5 4 3 2 1

MOLEX P/N	CIRCUIT SIZE	HOUSING MATERIAL	HOUSING COLOR	TERMINAL MATERIAL	CONTACT PLATING	SOLDER TAIL 'D' LENGTH	
87715-6000	36	NYLON66	BLACK	PHOSPHOR BRONZE	GOLD FLASH	2.54	
87715-6001					10 MICROINCH		
87715-6002					15 MICROINCH		
87715-6003					GOLD FLASH		
87715-6004					10 MICROINCH		3.00
87715-6005					15 MICROINCH		
87715-6006					30 MICROINCH		2.54
87715-6007					GOLD FLASH		
87715-6008					15 MICROINCH		2.30
87715-6009					30 MICROINCH		3.00
87715-6010	36	NYLON66	WHITE	PHOSPHOR BRONZE	GOLD FLASH	2.54	
87715-6011					10 MICROINCH		
87715-6012					15 MICROINCH		
87715-6013					GOLD FLASH		
87715-6014					10 MICROINCH		3.00
87715-6015					15 MICROINCH		
87715-6016					30 MICROINCH		2.54
87715-6017					GOLD FLASH		
87715-6018					15 MICROINCH		2.30
87715-6020					36		NYLON66
87715-6021	10 MICROINCH						
87715-6022	15 MICROINCH						
87715-6023	GOLD FLASH						
87715-6024	10 MICROINCH	3.00					
87715-6025	15 MICROINCH						
87715-6026	30 MICROINCH	2.54					
87715-6027	GOLD FLASH						
87715-6028	15 MICROINCH	2.30					
87715-6030	36	NYLON66	GREEN (348C)	PHOSPHOR BRONZE		GOLD FLASH	
87715-6031					10 MICROINCH		
87715-6032					15 MICROINCH		
87715-6033					GOLD FLASH		
87715-6034					10 MICROINCH	3.00	
87715-6035					15 MICROINCH		
87715-6036					30 MICROINCH	2.54	
87715-6037					GOLD FLASH		
87715-6038					15 MICROINCH	2.30	
87715-6040					36	NYLON66	PURPLE (2736U)
87715-6041	10 MICROINCH						
87715-6042	15 MICROINCH						
87715-6043	GOLD FLASH						
87715-6044	10 MICROINCH	3.00					
87715-6045	15 MICROINCH						
87715-6046	30 MICROINCH	2.54					
87715-6047	GOLD FLASH						
87715-6048	15 MICROINCH	2.30					

MOLEX P/N	CIRCUIT SIZE	HOUSING MATERIAL	HOUSING COLOR	TERMINAL MATERIAL	CONTACT PLATING	SOLDER TAIL 'D' LENGTH	
87715-6100	64	NYLON66	BLACK	PHOSPHOR BRONZE	GOLD FLASH	2.54	
87715-6101					10 MICROINCH		
87715-6102					15 MICROINCH		
87715-6103					GOLD FLASH		
87715-6104					10 MICROINCH		3.00
87715-6105					15 MICROINCH		
87715-6106					30 MICROINCH		2.54
87715-6107					GOLD FLASH		
87715-6108					15 MICROINCH		2.30
87715-6109					30 MICROINCH		3.00
87715-6110	64	NYLON66	WHITE	PHOSPHOR BRONZE	GOLD FLASH	2.54	
87715-6111					10 MICROINCH		
87715-6112					15 MICROINCH		
87715-6113					GOLD FLASH		
87715-6114					10 MICROINCH		3.00
87715-6115					15 MICROINCH		
87715-6116					30 MICROINCH		2.54
87715-6117					GOLD FLASH		
87715-6118					15 MICROINCH		2.30
87715-6120					64		NYLON66
87715-6121	10 MICROINCH						
87715-6122	15 MICROINCH						
87715-6123	GOLD FLASH						
87715-6124	10 MICROINCH	3.00					
87715-6125	15 MICROINCH						
87715-6126	30 MICROINCH	2.54					
87715-6127	GOLD FLASH						
87715-6128	15 MICROINCH	2.30					
87715-6130	64	NYLON66	GREEN (348C)	PHOSPHOR BRONZE		GOLD FLASH	
87715-6131					10 MICROINCH		
87715-6132					15 MICROINCH		
87715-6133					GOLD FLASH		
87715-6134					10 MICROINCH	3.00	
87715-6135					15 MICROINCH		
87715-6136					30 MICROINCH	2.54	
87715-6137					GOLD FLASH		
87715-6138					15 MICROINCH	2.30	
87715-6140					64	NYLON66	PURPLE (2736U)
87715-6141	10 MICROINCH						
87715-6142	15 MICROINCH						
87715-6143	GOLD FLASH						
87715-6144	10 MICROINCH	3.00					
87715-6145	15 MICROINCH						
87715-6146	30 MICROINCH	2.54					
87715-6147	GOLD FLASH						
87715-6148	15 MICROINCH	2.30					

SEE SHEET 1
 EC NO: SH2009-0199
 DRWN:GWANG08 2008/08/19/17
 CHKD:DMZHANG02
 APPR:HWANG 2008/11/03
 REV

QUALITY SYMBOLS
 = 0
 = 0

GENERAL TOLERANCES (UNLESS SPECIFIED)

	mm	INCH
4 PLACES	± .005	± .0002
3 PLACES	± .008	± .0003
2 PLACES	± 0.25	± .010
1 PLACE	± 0.25	± .010

ANGULAR ± 3 °

DRAFT WHERE APPLICABLE MUST REMAIN WITHIN DIMENSIONS

DIMENSION STYLE
MM ONLY

DRAWN BY: TOM DATE: 2004/07/20
 CHECKED BY: ALLEN LIN DATE: 2004/07/20
 APPROVED BY: WILSON DATE: 2004/07/20

MATERIAL NO. SEE TABLE

SCALE: METRIC
 DESIGN UNITS: METRIC
 THIRD ANGLE PROJECTION

PCI EXPRESS
 EDGE CARD CONNECTOR
 (LEAD FREE VERSION)

 MOLEX INCORPORATED

DOCUMENT NO. SD-87715-207 SHEET NO. 4 OF 11

THIS DRAWING CONTAINS INFORMATION THAT IS PROPRIETARY TO MOLEX INCORPORATED AND SHOULD NOT BE USED WITHOUT WRITTEN PERMISSION

9 8 7 6 5 4 3 2 1



MOLEX P/N	CIRCUIT SIZE	HOUSING MATERIAL	HOUSING COLOR	TERMINAL MATERIAL	CONTACT PLATING	SOLDER TAIL 'D' LENGTH	
87715-6200	98	NYLON66	BLACK	PHOSPHOR BRONZE	GOLD FLASH	2.54	
87715-6201					10 MICROINCH		
87715-6202					15 MICROINCH		
87715-6203					GOLD FLASH		
87715-6204					10 MICROINCH		3.00
87715-6205					15 MICROINCH		
87715-6206					30 MICROINCH		2.54
87715-6207					GOLD FLASH		2.30
87715-6208					15 MICROINCH		
87715-6209					30 MICROINCH		3.00
87715-6210	98	NYLON66	WHITE	PHOSPHOR BRONZE	GOLD FLASH	2.54	
87715-6211					10 MICROINCH		
87715-6212					15 MICROINCH		
87715-6213					GOLD FLASH		
87715-6214					10 MICROINCH		3.00
87715-6215					15 MICROINCH		
87715-6216					30 MICROINCH		2.54
87715-6217					GOLD FLASH		2.30
87715-6218					15 MICROINCH		
87715-6220					98		NYLON66
87715-6221	10 MICROINCH						
87715-6222	15 MICROINCH						
87715-6223	GOLD FLASH						
87715-6224	10 MICROINCH	3.00					
87715-6225	15 MICROINCH						
87715-6226	30 MICROINCH	2.54					
87715-6227	GOLD FLASH	2.30					
87715-6228	15 MICROINCH						
87715-6230	98	NYLON66	GREEN (348C)	PHOSPHOR BRONZE		GOLD FLASH	
87715-6231					10 MICROINCH		
87715-6232					15 MICROINCH		
87715-6233					GOLD FLASH		
87715-6234					10 MICROINCH	3.00	
87715-6235					15 MICROINCH		
87715-6236					30 MICROINCH	2.54	
87715-6237					GOLD FLASH	2.30	
87715-6238					15 MICROINCH		
87715-6240					98	NYLON66	PURPLE (2736U)
87715-6241	10 MICROINCH						
87715-6242	15 MICROINCH						
87715-6243	GOLD FLASH						
87715-6244	10 MICROINCH	3.00					
87715-6245	15 MICROINCH						
87715-6246	30 MICROINCH	2.54					
87715-6247	GOLD FLASH	2.30					
87715-6248	15 MICROINCH						

MOLEX P/N	CIRCUIT SIZE	HOUSING MATERIAL	HOUSING COLOR	TERMINAL MATERIAL	CONTACT PLATING	SOLDER TAIL 'D' LENGTH	
87715-6300	164	NYLON66	BLACK	PHOSPHOR BRONZE	GOLD FLASH	2.54	
87715-6301					10 MICROINCH		
87715-6302					15 MICROINCH		
87715-6303					GOLD FLASH		
87715-6304					10 MICROINCH		3.00
87715-6305					15 MICROINCH		
87715-6306					30 MICROINCH		2.54
87715-6307					GOLD FLASH		2.30
87715-6308					15 MICROINCH		
87715-6309					30 MICROINCH		3.00
87715-6310	164	NYLON66	WHITE	PHOSPHOR BRONZE	GOLD FLASH	2.54	
87715-6311					10 MICROINCH		
87715-6312					15 MICROINCH		
87715-6313					GOLD FLASH		
87715-6314					10 MICROINCH		3.00
87715-6315					15 MICROINCH		
87715-6316					30 MICROINCH		2.54
87715-6317					GOLD FLASH		2.30
87715-6318					15 MICROINCH		
87715-6320					164		NYLON66
87715-6321	10 MICROINCH						
87715-6322	15 MICROINCH						
87715-6323	GOLD FLASH						
87715-6324	10 MICROINCH	3.00					
87715-6325	15 MICROINCH						
87715-6326	30 MICROINCH	2.54					
87715-6327	GOLD FLASH	2.30					
87715-6328	15 MICROINCH						
87715-6330	164	NYLON66	GREEN (348C)	PHOSPHOR BRONZE		GOLD FLASH	
87715-6331					10 MICROINCH		
87715-6332					15 MICROINCH		
87715-6333					GOLD FLASH		
87715-6334					10 MICROINCH	3.00	
87715-6335					15 MICROINCH		
87715-6336					30 MICROINCH	2.54	
87715-6337					GOLD FLASH	2.30	
87715-6338					15 MICROINCH		
87715-6340					164	NYLON66	PURPLE (2736U)
87715-6341	10 MICROINCH						
87715-6342	15 MICROINCH						
87715-6343	GOLD FLASH						
87715-6344	10 MICROINCH	3.00					
87715-6345	15 MICROINCH						
87715-6346	30 MICROINCH	2.54					
87715-6347	GOLD FLASH	2.30					
87715-6348	15 MICROINCH						

2008/10/17

2008/10/17

SEE SHEET 1
 EC NO: SH2009-0199
 DRW:GWANG08 2008/10/13
 CHK:DMZHANG02 2008/10/17
 APPR:HWANG 2008/11/03

QUALITY SYMBOLS
 = 0.05
 = 0.1

GENERAL TOLERANCES (UNLESS SPECIFIED)

	mm	INCH
4 PLACES	± .10	± .004
3 PLACES	± .15	± .006
2 PLACES	± 0.25	± .010
1 PLACE	± 0.25	± .010
ANGULAR ± 3 °		

DRAFT WHERE APPLICABLE
 MUST REMAIN WITHIN DIMENSIONS

DIMENSION STYLE
MM ONLY

DRAWN BY: TOM DATE: 2004/07/20
 CHECKED BY: ALLEN LIN DATE: 2004/07/20
 APPROVED BY: WILSON DATE: 2004/07/20

MATERIAL NO. SEE TABLE

SCALE: METRIC
 DESIGN UNITS: MM
 THIRD ANGLE PROJECTION

TITLE: PCI EXPRESS EDGE CARD CONNECTOR (LEAD FREE VERSION)

 MOLEX INCORPORATED

DOCUMENT NO. SD-87715-207 SHEET NO. 5 OF 11

THIS DRAWING CONTAINS INFORMATION THAT IS PROPRIETARY TO MOLEX INCORPORATED AND SHOULD NOT BE USED WITHOUT WRITTEN PERMISSION

MOLEX P/N	CIRCUIT SIZE	HOUSING MATERIAL	HOUSING COLOR	TERMINAL MATERIAL	CONTACT PLATING	SOLDER TAIL 'D' LENGTH
87715-6400	36	NYLON66	BLACK	BRASS	GOLD FLASH	2.54
87715-6401					10 MICROINCH	
87715-6402					15 MICROINCH	
87715-6403					GOLD FLASH	
87715-6404					10 MICROINCH	
87715-6405					15 MICROINCH	
87715-6406	30 MICROINCH	2.54				
87715-6407	GOLD FLASH	3.00				
87715-6408	15 MICROINCH					
87715-6410	GOLD FLASH					
87715-6411	10 MICROINCH					
87715-6412	15 MICROINCH					
87715-6413	GOLD FLASH					
87715-6414	10 MICROINCH					
87715-6415	15 MICROINCH					
87715-6416	30 MICROINCH	2.54				
87715-6417	GOLD FLASH					
87715-6418	15 MICROINCH	2.30				
87715-6420	GOLD FLASH	2.54				
87715-6421	10 MICROINCH					
87715-6422	15 MICROINCH					
87715-6423	GOLD FLASH					
87715-6424	10 MICROINCH					
87715-6425	15 MICROINCH					
87715-6426	30 MICROINCH	2.54				
87715-6427	GOLD FLASH					
87715-6428	15 MICROINCH	2.30				
87715-6430	GOLD FLASH	2.54				
87715-6431	10 MICROINCH					
87715-6432	15 MICROINCH					
87715-6433	GOLD FLASH					
87715-6434	10 MICROINCH					
87715-6435	15 MICROINCH					
87715-6436	30 MICROINCH	2.54				
87715-6437	GOLD FLASH					
87715-6438	15 MICROINCH	2.30				
87715-6440	GOLD FLASH	2.54				
87715-6441	10 MICROINCH					
87715-6442	15 MICROINCH					
87715-6443	GOLD FLASH					
87715-6444	10 MICROINCH					
87715-6445	15 MICROINCH					
87715-6446	30 MICROINCH	2.54				
87715-6447	GOLD FLASH					
87715-6448	15 MICROINCH	2.30				

MOLEX P/N	CIRCUIT SIZE	HOUSING MATERIAL	HOUSING COLOR	TERMINAL MATERIAL	CONTACT PLATING	SOLDER TAIL 'D' LENGTH
87715-6500	64	NYLON66	BLACK	BRASS	GOLD FLASH	2.54
87715-6501					10 MICROINCH	
87715-6502					15 MICROINCH	
87715-6503					GOLD FLASH	
87715-6504					10 MICROINCH	
87715-6505					15 MICROINCH	
87715-6506	30 MICROINCH	2.54				
87715-6507	GOLD FLASH	3.00				
87715-6508	15 MICROINCH					
87715-6510	GOLD FLASH					
87715-6511	10 MICROINCH					
87715-6512	15 MICROINCH					
87715-6513	GOLD FLASH					
87715-6514	10 MICROINCH					
87715-6515	15 MICROINCH					
87715-6516	30 MICROINCH	2.54				
87715-6517	GOLD FLASH					
87715-6518	15 MICROINCH	2.30				
87715-6520	GOLD FLASH	2.54				
87715-6521	10 MICROINCH					
87715-6522	15 MICROINCH					
87715-6523	GOLD FLASH					
87715-6524	10 MICROINCH					
87715-6525	15 MICROINCH					
87715-6526	30 MICROINCH	2.54				
87715-6527	GOLD FLASH					
87715-6528	15 MICROINCH	2.30				
87715-6530	GOLD FLASH	2.54				
87715-6531	10 MICROINCH					
87715-6532	15 MICROINCH					
87715-6533	GOLD FLASH					
87715-6534	10 MICROINCH					
87715-6535	15 MICROINCH					
87715-6536	30 MICROINCH	2.54				
87715-6537	GOLD FLASH					
87715-6538	15 MICROINCH	2.30				
87715-6540	GOLD FLASH	2.54				
87715-6541	10 MICROINCH					
87715-6542	15 MICROINCH					
87715-6543	GOLD FLASH					
87715-6544	10 MICROINCH					
87715-6545	15 MICROINCH					
87715-6546	30 MICROINCH	2.54				
87715-6547	GOLD FLASH					
87715-6548	15 MICROINCH	2.30				

SEE SHEET 2008/10/17

EC NO: SH2009-0199 2008/10/13
 DRWNG:GWANG08 2008/10/17
 CHK:DMZHANG02 2008/10/17
 APPR:HWANG 2008/11/03

DESCRIPTION
 REV

QUALITY SYMBOLS	GENERAL TOLERANCES (UNLESS SPECIFIED)	
	mm	INCH
	± ---	± ---
	± ---	± ---
	± 0.25	± ---
	± 0.25	± ---
	ANGULAR ± 3 °	

DRAFT WHERE APPLICABLE
 MUST REMAIN
 WITHIN DIMENSIONS

DIMENSION STYLE	
MM ONLY	
DRAWN BY	DATE
TOM	2004/07/20
CHECKED BY	DATE
ALLEN LIN	2004/07/20
APPROVED BY	DATE
WILSON	2004/07/20
MATERIAL NO.	DOCUMENT NO.
SEE TABLE	SD-87715-207

SCALE: METRIC 2008/10/17

DESIGN UNITS: METRIC

THIRD ANGLE PROJECTION

TITLE: PCI EXPRESS
 EDGE CARD CONNECTOR
 (LEAD FREE VERSION)

MOLEX INCORPORATED

SHEET NO. 6 OF 11

THIS DRAWING CONTAINS INFORMATION THAT IS PROPRIETARY TO MOLEX INCORPORATED AND SHOULD NOT BE USED WITHOUT WRITTEN PERMISSION

MOLEX P/N	CIRCUIT SIZE	HOUSING MATERIAL	HOUSING COLOR	TERMINAL MATERIAL	CONTACT PLATING	SOLDER TAIL 'D' LENGTH	
87715-6600	98	NYLON66	BLACK	BRASS	GOLD FLASH	2.54	
87715-6601					10 MICROINCH		
87715-6602					15 MICROINCH		
87715-6603					GOLD FLASH		3.00
87715-6604					10 MICROINCH		
87715-6605					15 MICROINCH		
87715-6606					30 MICROINCH		2.54
87715-6607					GOLD FLASH		2.30
87715-6608					15 MICROINCH		
87715-6610					98		NYLON66
87715-6611	10 MICROINCH						
87715-6612	15 MICROINCH						
87715-6613	GOLD FLASH	3.00					
87715-6614	10 MICROINCH						
87715-6615	15 MICROINCH						
87715-6616	30 MICROINCH	2.54					
87715-6617	GOLD FLASH	2.30					
87715-6618	15 MICROINCH						
87715-6620	98	NYLON66	BLUE (287U)	BRASS		GOLD FLASH	
87715-6621					10 MICROINCH		
87715-6622					15 MICROINCH		
87715-6623					GOLD FLASH	3.00	
87715-6624					10 MICROINCH		
87715-6625					15 MICROINCH		
87715-6626					30 MICROINCH	2.54	
87715-6627					GOLD FLASH	2.30	
87715-6628					15 MICROINCH		
87715-6630					98	NYLON66	GREEN (348C)
87715-6631	10 MICROINCH						
87715-6632	15 MICROINCH						
87715-6633	GOLD FLASH	3.00					
87715-6634	10 MICROINCH						
87715-6635	15 MICROINCH						
87715-6636	30 MICROINCH	2.54					
87715-6637	GOLD FLASH	2.30					
87715-6638	15 MICROINCH						
87715-6640	98	NYLON66	PURPLE (2736U)	BRASS			
87715-6641					10 MICROINCH		
87715-6642					15 MICROINCH		
87715-6643					GOLD FLASH	3.00	
87715-6644					10 MICROINCH		
87715-6645					15 MICROINCH		
87715-6646					30 MICROINCH	2.54	
87715-6647					GOLD FLASH	2.30	
87715-6648					15 MICROINCH		

MOLEX P/N	CIRCUIT SIZE	HOUSING MATERIAL	HOUSING COLOR	TERMINAL MATERIAL	CONTACT PLATING	SOLDER TAIL 'D' LENGTH	
87715-6700	164	NYLON66	BLACK	BRASS	GOLD FLASH	2.54	
87715-6701					10 MICROINCH		
87715-6702					15 MICROINCH		
87715-6703					GOLD FLASH		3.00
87715-6704					10 MICROINCH		
87715-6705					15 MICROINCH		
87715-6706					30 MICROINCH		2.54
87715-6707					GOLD FLASH		2.30
87715-6708					15 MICROINCH		
87715-6710					164		NYLON66
87715-6711	10 MICROINCH						
87715-6712	15 MICROINCH						
87715-6713	GOLD FLASH	3.00					
87715-6714	10 MICROINCH						
87715-6715	15 MICROINCH						
87715-6716	30 MICROINCH	2.54					
87715-6717	GOLD FLASH	2.30					
87715-6718	15 MICROINCH						
87715-6720	164	NYLON66	BLUE (287U)	BRASS		GOLD FLASH	
87715-6721					10 MICROINCH		
87715-6722					15 MICROINCH		
87715-6723					GOLD FLASH	3.00	
87715-6724					10 MICROINCH		
87715-6725					15 MICROINCH		
87715-6726					30 MICROINCH	2.54	
87715-6727					GOLD FLASH	2.30	
87715-6728					15 MICROINCH		
87715-6730					164	NYLON66	GREEN (348C)
87715-6731	10 MICROINCH						
87715-6732	15 MICROINCH						
87715-6733	GOLD FLASH	3.00					
87715-6734	10 MICROINCH						
87715-6735	15 MICROINCH						
87715-6736	30 MICROINCH	2.54					
87715-6737	GOLD FLASH	2.30					
87715-6738	15 MICROINCH						
87715-6740	164	NYLON66	PURPLE (2736U)	BRASS			
87715-6741					10 MICROINCH		
87715-6742					15 MICROINCH		
87715-6743					GOLD FLASH	3.00	
87715-6744					10 MICROINCH		
87715-6745					15 MICROINCH		
87715-6746					30 MICROINCH	2.54	
87715-6747					GOLD FLASH	2.30	
87715-6748					15 MICROINCH		

SEE SHEET 2008/10/17
 EC NO: SH2009-0199
 DRWN: GWANG08 2008/10/13
 CH'KD: DMZHANG02 2008/10/17
 APPR: HWANG 2008/11/03

QUALITY SYMBOLS	GENERAL TOLERANCES (UNLESS SPECIFIED)	
	mm	INCH
▽=0	4 PLACES ± ---	± ---
▽=0	3 PLACES ± ---	± ---
	2 PLACES ± 0.25	± ---
	1 PLACE ± 0.25	± ---
	ANGULAR ± 3 °	

DIMENSION STYLE		SCALE	DESIGN UNITS
MM ONLY			METRIC
DRAWN BY	DATE	TITLE	
TOM	2004/07/20	PCI EXPRESS	
CHECKED BY	DATE	EDGE CARD CONNECTOR	
ALLEN LIN	2004/07/20	(LEAD FREE VERSION)	
APPROVED BY	DATE	MOLEX INCORPORATED	
WILSON	2004/07/20	MATERIAL NO. DOCUMENT NO.	
SEE TABLE		SD-87715-207	

THIRD ANGLE PROJECTION	
DRAFT WHERE APPLICABLE MUST REMAIN WITHIN DIMENSIONS	
SIZE A3	THIS DRAWING CONTAINS INFORMATION THAT IS PROPRIETARY TO MOLEX INCORPORATED AND SHOULD NOT BE USED WITHOUT WRITTEN PERMISSION
SHEET NO. 7 OF 11	

MOLEX P/N	CIRCUIT SIZE	HOUSING MATERIAL	HOUSING COLOR	TERMINAL MATERIAL	CONTACT PLATING	SOLDER TAIL 'D' LENGTH	
87715-9000	36	NYLON46	BLACK	PHOSPHOR BRONZE	GOLD FLASH	2.54	
87715-9001					10 MICROINCH		
87715-9002					15 MICROINCH		
87715-9003					GOLD FLASH		
87715-9004					10 MICROINCH		3.00
87715-9005					15 MICROINCH		
87715-9006					30 MICROINCH		2.54
87715-9007					GOLD FLASH		2.30
87715-9008					15 MICROINCH		
87715-9009	30 MICROINCH	3.00					
87715-9010	36	NYLON46	WHITE	PHOSPHOR BRONZE	GOLD FLASH	2.54	
87715-9011					10 MICROINCH		
87715-9012					15 MICROINCH		
87715-9013					GOLD FLASH		
87715-6014					10 MICROINCH		3.00
87715-9015					15 MICROINCH		
87715-9016					30 MICROINCH		2.54
87715-9017					GOLD FLASH		2.30
87715-9018					15 MICROINCH		
87715-9020	36	NYLON46	BLUE (287U)	PHOSPHOR BRONZE	GOLD FLASH	2.54	
87715-9021					10 MICROINCH		
87715-9022					15 MICROINCH		
87715-9023					GOLD FLASH		
87715-9024					10 MICROINCH		3.00
87715-9025					15 MICROINCH		
87715-9026					30 MICROINCH		2.54
87715-9027					GOLD FLASH		2.30
87715-9028					15 MICROINCH		
87715-9030	36	NYLON46	GREEN (348C)	PHOSPHOR BRONZE	GOLD FLASH	2.54	
87715-9031					10 MICROINCH		
87715-9032					15 MICROINCH		
87715-9033					GOLD FLASH		
87715-9034					10 MICROINCH		3.00
87715-9035					15 MICROINCH		
87715-9036					30 MICROINCH		2.54
87715-9037					GOLD FLASH		2.30
87715-9038					15 MICROINCH		
87715-9040	36	NYLON46	PURPLE (2736U)	PHOSPHOR BRONZE	GOLD FLASH	2.54	
87715-9041					10 MICROINCH		
87715-9042					15 MICROINCH		
87715-9043					GOLD FLASH		
87715-9044					10 MICROINCH		3.00
87715-9045					15 MICROINCH		
87715-9046					30 MICROINCH		2.54
87715-9047					GOLD FLASH		2.30
87715-9048					15 MICROINCH		

MOLEX P/N	CIRCUIT SIZE	HOUSING MATERIAL	HOUSING COLOR	TERMINAL MATERIAL	CONTACT PLATING	SOLDER TAIL 'D' LENGTH	
87715-9100	64	NYLON46	BLACK	PHOSPHOR BRONZE	GOLD FLASH	2.54	
87715-9101					10 MICROINCH		
87715-9102					15 MICROINCH		
87715-9103					GOLD FLASH		
87715-9104					10 MICROINCH		3.00
87715-9105					15 MICROINCH		
87715-9106					30 MICROINCH		2.54
87715-9107					GOLD FLASH		2.30
87715-9108					15 MICROINCH		
87715-9109	30 MICROINCH	3.00					
87715-9110	64	NYLON46	WHITE	PHOSPHOR BRONZE	GOLD FLASH	2.54	
87715-9111					10 MICROINCH		
87715-9112					15 MICROINCH		
87715-9113					GOLD FLASH		
87715-9114					10 MICROINCH		3.00
87715-9115					15 MICROINCH		
87715-9116					30 MICROINCH		2.54
87715-9117					GOLD FLASH		2.30
87715-9118					15 MICROINCH		
87715-9120	64	NYLON46	BLUE (287U)	PHOSPHOR BRONZE	GOLD FLASH	2.54	
87715-9121					10 MICROINCH		
87715-9122					15 MICROINCH		
87715-9123					GOLD FLASH		
87715-9124					10 MICROINCH		3.00
87715-9125					15 MICROINCH		
87715-9126					30 MICROINCH		2.54
87715-9127					GOLD FLASH		2.30
87715-9128					15 MICROINCH		
87715-9130	64	NYLON46	GREEN (348C)	PHOSPHOR BRONZE	GOLD FLASH	2.54	
87715-9131					10 MICROINCH		
87715-9132					15 MICROINCH		
87715-9133					GOLD FLASH		
87715-9134					10 MICROINCH		3.00
87715-9135					15 MICROINCH		
87715-9136					30 MICROINCH		2.54
87715-9137					GOLD FLASH		2.30
87715-9138					15 MICROINCH		
87715-9140	64	NYLON46	PURPLE (2736U)	PHOSPHOR BRONZE	GOLD FLASH	2.54	
87715-9141					10 MICROINCH		
87715-9142					15 MICROINCH		
87715-9143					GOLD FLASH		
87715-9144					10 MICROINCH		3.00
87715-9145					15 MICROINCH		
87715-9146					30 MICROINCH		2.54
87715-9147					GOLD FLASH		2.30
87715-9148					15 MICROINCH		

SEE SHEET 2008/10/17

EC NO: SH2009-0199 2008/10/13
 DRWG:GMANG08 2008/10/17
 CHK:DMZHANG02 2008/10/17
 APPR:HWANG 2008/11/03

REV DESCRIPTION

QUALITY SYMBOLS	GENERAL TOLERANCES (UNLESS SPECIFIED)	
	mm	INCH
	± ---	± ---
	± ---	± ---
	± 0.25	± ---
	± 0.25	± ---
	ANGULAR ± 3 °	

DRAFT WHERE APPLICABLE
MUST REMAIN WITHIN DIMENSIONS

DIMENSION STYLE		SCALE	DESIGN UNITS
MM ONLY			METRIC
DRAWN BY	DATE	TITLE	
TOM	2004/07/20	PCI EXPRESS	
CHECKED BY	DATE	EDGE CARD CONNECTOR	
ALLEN LIN	2004/07/20	(LEAD FREE VERSION)	
APPROVED BY	DATE	MOLEX INCORPORATED	
WILSON	2004/07/20		
MATERIAL NO.	DOCUMENT NO.	SHEET NO.	
SEE TABLE	SD-87715-207	8 OF 11	

THIRD ANGLE PROJECTION

PCI EXPRESS
EDGE CARD CONNECTOR
(LEAD FREE VERSION)

MOLEX INCORPORATED

THIS DRAWING CONTAINS INFORMATION THAT IS PROPRIETARY TO MOLEX INCORPORATED AND SHOULD NOT BE USED WITHOUT WRITTEN PERMISSION

10 9 8 7 6 5 4 3 2 1

MOLEX P/N	CIRCUIT SIZE	HOUSING MATERIAL	HOUSING COLOR	TERMINAL MATERIAL	CONTACT PLATING	SOLDER TAIL 'D' LENGTH
87715-9200	98	NYLON46	BLACK	PHOSPHOR BRONZE	GOLD FLASH	2.54
87715-9201					10 MICROINCH	
87715-9202					15 MICROINCH	
87715-9203					GOLD FLASH	
87715-9204					10 MICROINCH	
87715-9205					15 MICROINCH	
87715-9206					30 MICROINCH	
87715-9207					GOLD FLASH	
87715-9208					15 MICROINCH	
87715-9209	30 MICROINCH	3.00				
87715-9210	98	NYLON46	WHITE	PHOSPHOR BRONZE	GOLD FLASH	2.54
87715-9211					10 MICROINCH	
87715-9212					15 MICROINCH	
87715-9213					GOLD FLASH	
87715-9214					10 MICROINCH	
87715-9215					15 MICROINCH	
87715-9216					30 MICROINCH	
87715-9217					GOLD FLASH	
87715-9218					15 MICROINCH	
87715-9220	98	NYLON46	BLUE (287U)	PHOSPHOR BRONZE	GOLD FLASH	2.54
87715-9221					10 MICROINCH	
87715-9222					15 MICROINCH	
87715-9223					GOLD FLASH	
87715-9224					10 MICROINCH	
87715-9225					15 MICROINCH	
87715-9226					30 MICROINCH	
87715-9227					GOLD FLASH	
87715-9228					15 MICROINCH	
87715-9230	98	NYLON46	GREEN (348C)	PHOSPHOR BRONZE	GOLD FLASH	2.54
87715-9231					10 MICROINCH	
87715-9232					15 MICROINCH	
87715-9233					GOLD FLASH	
87715-9234					10 MICROINCH	
87715-9235					15 MICROINCH	
87715-9236					30 MICROINCH	
87715-9237					GOLD FLASH	
87715-9238					15 MICROINCH	
87715-9240	98	NYLON46	PURPLE (2736U)	PHOSPHOR BRONZE	GOLD FLASH	2.54
87715-9241					10 MICROINCH	
87715-9242					15 MICROINCH	
87715-9243					GOLD FLASH	
87715-9244					10 MICROINCH	
87715-9245					15 MICROINCH	
87715-9246					30 MICROINCH	
87715-9247					GOLD FLASH	
87715-9248					15 MICROINCH	

MOLEX P/N	CIRCUIT SIZE	HOUSING MATERIAL	HOUSING COLOR	TERMINAL MATERIAL	CONTACT PLATING	SOLDER TAIL 'D' LENGTH
87715-9300	164	NYLON46	BLACK	PHOSPHOR BRONZE	GOLD FLASH	2.54
87715-9301					10 MICROINCH	
87715-9302					15 MICROINCH	
87715-9303					GOLD FLASH	
87715-9304					10 MICROINCH	
87715-9305					15 MICROINCH	
87715-9306					30 MICROINCH	
87715-9307					GOLD FLASH	
87715-9308					15 MICROINCH	
87715-9309	30 MICROINCH	3.00				
87715-9310	164	NYLON46	WHITE	PHOSPHOR BRONZE	GOLD FLASH	2.54
87715-9311					10 MICROINCH	
87715-9312					15 MICROINCH	
87715-9313					GOLD FLASH	
87715-9314					10 MICROINCH	
87715-9315					15 MICROINCH	
87715-9316					30 MICROINCH	
87715-9317					GOLD FLASH	
87715-9318					15 MICROINCH	
87715-9320	164	NYLON46	BLUE (287U)	PHOSPHOR BRONZE	GOLD FLASH	2.54
87715-9321					10 MICROINCH	
87715-9322					15 MICROINCH	
87715-9323					GOLD FLASH	
87715-9324					10 MICROINCH	
87715-9325					15 MICROINCH	
87715-9326					30 MICROINCH	
87715-9327					GOLD FLASH	
87715-9328					15 MICROINCH	
87715-9330	164	NYLON46	GREEN (348C)	PHOSPHOR BRONZE	GOLD FLASH	2.54
87715-9331					10 MICROINCH	
87715-9332					15 MICROINCH	
87715-9333					GOLD FLASH	
87715-9334					10 MICROINCH	
87715-9335					15 MICROINCH	
87715-9336					30 MICROINCH	
87715-9337					GOLD FLASH	
87715-9338					15 MICROINCH	
87715-9340	164	NYLON46	PURPLE (2736U)	PHOSPHOR BRONZE	GOLD FLASH	2.54
87715-9341					10 MICROINCH	
87715-9342					15 MICROINCH	
87715-9343					GOLD FLASH	
87715-9344					10 MICROINCH	
87715-9345					15 MICROINCH	
87715-9346					30 MICROINCH	
87715-9347					GOLD FLASH	
87715-9348					15 MICROINCH	
87715-9352	164	NYLON46	BLUE (659C)	PHOSPHOR BRONZE	GOLD FLASH	2.54
87715-9355					15 MICROINCH	3.00

▽

SEE SHEET 1
 EC NO: SH2009-0199 2008/10/17
 DRW:GWANG08 2008/10/15
 CHK:DMZHANG02 2008/10/17
 APPR:HWANG 2008/11/03

QUALITY SYMBOLS
 ▽=0
 ▽=0

GENERAL TOLERANCES (UNLESS SPECIFIED)

	mm	INCH
4 PLACES	± .005	± .0004
3 PLACES	± .008	± .0003
2 PLACES	± 0.25	± .010
1 PLACE	± 0.25	± .010
ANGULAR ± 3 °		

DRAFT WHERE APPLICABLE MUST REMAIN WITHIN DIMENSIONS

DIMENSION STYLE
MM ONLY

DRAWN BY: TOM DATE: 2004/07/20
 CHECKED BY: ALLEN LIN DATE: 2004/07/20
 APPROVED BY: WILSON DATE: 2004/07/20

MATERIAL NO. SEE TABLE

SCALE
 DESIGN UNITS
METRIC

THIRD ANGLE PROJECTION

PCI EXPRESS
 EDGE CARD CONNECTOR
 (LEAD FREE VERSION)

MOLEX INCORPORATED

DOCUMENT NO. SD-87715-207 SHEET NO. 9 OF 11

THIS DRAWING CONTAINS INFORMATION THAT IS PROPRIETARY TO MOLEX INCORPORATED AND SHOULD NOT BE USED WITHOUT WRITTEN PERMISSION

9 8 7 6 5 4 3 2 1

MOLEX P/N	CIRCUIT SIZE	HOUSING MATERIAL	HOUSING COLOR	TERMINAL MATERIAL	CONTACT PLATING	SOLDER TAIL 'D' LENGTH	
87715-9400	36	NYLON46	BLACK	BRASS	GOLD FLASH	2.54	
87715-9401					10 MICROINCH		
87715-9402					15 MICROINCH		
87715-9403					GOLD FLASH		
87715-9404					10 MICROINCH		3.00
87715-9405					15 MICROINCH		
87715-9406					30 MICROINCH		2.54
87715-9407					GOLD FLASH		
87715-9408	15 MICROINCH	2.30					
87715-9410	36	NYLON46	WHITE	BRASS	GOLD FLASH	2.54	
87715-9411					10 MICROINCH		
87715-9412					15 MICROINCH		
87715-9413					GOLD FLASH		
87715-9414					10 MICROINCH		3.00
87715-9415					15 MICROINCH		
87715-9416					30 MICROINCH		2.54
87715-9417					GOLD FLASH		
87715-9418	15 MICROINCH	2.30					
87715-9420	36	NYLON46	BLUE (287U)	BRASS	GOLD FLASH	2.54	
87715-9421					10 MICROINCH		
87715-9422					15 MICROINCH		
87715-9423					GOLD FLASH		
87715-9424					10 MICROINCH		3.00
87715-9425					15 MICROINCH		
87715-9426					30 MICROINCH		2.54
87715-9427					GOLD FLASH		
87715-9428	15 MICROINCH	2.30					
87715-9430	36	NYLON46	GREEN (348C)	BRASS	GOLD FLASH	2.54	
87715-9431					10 MICROINCH		
87715-9432					15 MICROINCH		
87715-9433					GOLD FLASH		
87715-9434					10 MICROINCH		3.00
87715-9435					15 MICROINCH		
87715-9436					30 MICROINCH		2.54
87715-9437					GOLD FLASH		
87715-9438	15 MICROINCH	2.30					
87715-9440	36	NYLON46	PURPLE (2736U)	BRASS	GOLD FLASH	2.54	
87715-9441					10 MICROINCH		
87715-9442					15 MICROINCH		
87715-9443					GOLD FLASH		
87715-9444					10 MICROINCH		3.00
87715-9445					15 MICROINCH		
87715-9446					30 MICROINCH		2.54
87715-9447					GOLD FLASH		
87715-9448	15 MICROINCH	2.30					

MOLEX P/N	CIRCUIT SIZE	HOUSING MATERIAL	HOUSING COLOR	TERMINAL MATERIAL	CONTACT PLATING	SOLDER TAIL 'D' LENGTH	
87715-9500	64	NYLON46	BLACK	BRASS	GOLD FLASH	2.54	
87715-9501					10 MICROINCH		
87715-9502					15 MICROINCH		
87715-9503					GOLD FLASH		
87715-9504					10 MICROINCH		3.00
87715-9505					15 MICROINCH		
87715-9506					30 MICROINCH		2.54
87715-9507					GOLD FLASH		
87715-9508	15 MICROINCH	2.30					
87715-9510	64	NYLON46	WHITE	BRASS	GOLD FLASH	2.54	
87715-9511					10 MICROINCH		
87715-9512					15 MICROINCH		
87715-9513					GOLD FLASH		
87715-9514					10 MICROINCH		3.00
87715-9515					15 MICROINCH		
87715-9516					30 MICROINCH		2.54
87715-9517					GOLD FLASH		
87715-9518	15 MICROINCH	2.30					
87715-9520	64	NYLON46	BLUE (287U)	BRASS	GOLD FLASH	2.54	
87715-9521					10 MICROINCH		
87715-9522					15 MICROINCH		
87715-9523					GOLD FLASH		
87715-9524					10 MICROINCH		3.00
87715-9525					15 MICROINCH		
87715-9526					30 MICROINCH		2.54
87715-9527					GOLD FLASH		
87715-9528	15 MICROINCH	2.30					
87715-9530	64	NYLON46	GREEN (348C)	BRASS	GOLD FLASH	2.54	
87715-9531					10 MICROINCH		
87715-9532					15 MICROINCH		
87715-9533					GOLD FLASH		
87715-9534					10 MICROINCH		3.00
87715-9535					15 MICROINCH		
87715-9536					30 MICROINCH		2.54
87715-9537					GOLD FLASH		
87715-9538	15 MICROINCH	2.30					
87715-9540	64	NYLON46	PURPLE (2736U)	BRASS	GOLD FLASH	2.54	
87715-9541					10 MICROINCH		
87715-9542					15 MICROINCH		
87715-9543					GOLD FLASH		
87715-9544					10 MICROINCH		3.00
87715-9545					15 MICROINCH		
87715-9546					30 MICROINCH		2.54
87715-9547					GOLD FLASH		
87715-9548	15 MICROINCH	2.30					

SEE SHEET 1 2008/10/17

EC NO: SH2009-0199 2008/10/13
 TDRW:GWANG08 2008/10/17
 CHKD:DMZHANG02 2008/10/17
 APPR:HWANG 2008/11/03

QUALITY SYMBOLS

GENERAL TOLERANCES (UNLESS SPECIFIED)

	mm	INCH
4 PLACES	± ---	± ---
3 PLACES	± ---	± ---
2 PLACES	± 0.25	± ---
1 PLACE	± 0.25	± ---
ANGULAR ± 3 °		

DRAFT WHERE APPLICABLE MUST REMAIN WITHIN DIMENSIONS

DIMENSION STYLE: MM ONLY

SCALE: THIRD ANGLE PROJECTION

DESIGN UNITS: METRIC

TITLE: PCI EXPRESS EDGE CARD CONNECTOR (LEAD FREE VERSION)

APPROVED BY: WILSON 2004/07/20

MATERIAL NO. SEE TABLE

DOCUMENT NO. SD-87715-207

SHEET NO. 10 OF 11

THIS DRAWING CONTAINS INFORMATION THAT IS PROPRIETARY TO MOLEX INCORPORATED AND SHOULD NOT BE USED WITHOUT WRITTEN PERMISSION

MOLEX P/N	CIRCUIT SIZE	HOUSING MATERIAL	HOUSING COLOR	TERMINAL MATERIAL	CONTACT PLATING	SOLDER TAIL 'D' LENGTH
87715-9600					GOLD FLASH	
87715-9601					10 MICROINCH	2.54
87715-9602					15 MICROINCH	
87715-9603					GOLD FLASH	
87715-9604	98	NYLON46	BLACK	BRASS	10 MICROINCH	3.00
87715-9605					15 MICROINCH	
87715-9606					30 MICROINCH	2.54
87715-9607					GOLD FLASH	
87715-9608					15 MICROINCH	2.30
87715-9610					GOLD FLASH	
87715-9611					10 MICROINCH	2.54
87715-9612					15 MICROINCH	
87715-9613					GOLD FLASH	
87715-9614	98	NYLON46	WHITE	BRASS	10 MICROINCH	3.00
87715-9615					15 MICROINCH	
87715-9616					30 MICROINCH	2.54
87715-9617					GOLD FLASH	
87715-9618					15 MICROINCH	2.30
87715-9620					GOLD FLASH	
87715-9621					10 MICROINCH	2.54
87715-9622					15 MICROINCH	
87715-9623					GOLD FLASH	
87715-9624	98	NYLON46	BLUE (287U)	BRASS	10 MICROINCH	3.00
87715-9625					15 MICROINCH	
87715-9626					30 MICROINCH	2.54
87715-9627					GOLD FLASH	
87715-9628					15 MICROINCH	2.30
87715-9630					GOLD FLASH	
87715-9631					10 MICROINCH	2.54
87715-9632					15 MICROINCH	
87715-9633					GOLD FLASH	
87715-9634	98	NYLON46	GREEN (348C)	BRASS	10 MICROINCH	3.00
87715-9635					15 MICROINCH	
87715-9636					30 MICROINCH	2.54
87715-9637					GOLD FLASH	
87715-9638					15 MICROINCH	2.30
87715-9640					GOLD FLASH	
87715-9641					10 MICROINCH	2.54
87715-9642					15 MICROINCH	
87715-9643					GOLD FLASH	
87715-9644	98	NYLON46	PURPLE (2736U)	BRASS	10 MICROINCH	3.00
87715-9645					15 MICROINCH	
87715-9646					30 MICROINCH	2.54
87715-9647					GOLD FLASH	
87715-9648					15 MICROINCH	2.30

MOLEX P/N	CIRCUIT SIZE	HOUSING MATERIAL	HOUSING COLOR	TERMINAL MATERIAL	CONTACT PLATING	SOLDER TAIL 'D' LENGTH
87715-9700					GOLD FLASH	
87715-9701					10 MICROINCH	2.54
87715-9702					15 MICROINCH	
87715-9703					GOLD FLASH	
87715-9704	164	NYLON46	BLACK	BRASS	10 MICROINCH	3.00
87715-9705					15 MICROINCH	
87715-9706					30 MICROINCH	2.54
87715-9707					GOLD FLASH	
87715-9708					15 MICROINCH	2.30
87715-9710					GOLD FLASH	
87715-9711					10 MICROINCH	2.54
87715-9712					15 MICROINCH	
87715-9713					GOLD FLASH	
87715-9714	164	NYLON46	WHITE	BRASS	10 MICROINCH	3.00
87715-9715					15 MICROINCH	
87715-9716					30 MICROINCH	2.54
87715-9717					GOLD FLASH	
87715-9718					15 MICROINCH	2.30
87715-9720					GOLD FLASH	
87715-9721					10 MICROINCH	2.54
87715-9722					15 MICROINCH	
87715-9723					GOLD FLASH	
87715-9724	164	NYLON46	BLUE (287U)	BRASS	10 MICROINCH	3.00
87715-9725					15 MICROINCH	
87715-9726					30 MICROINCH	2.54
87715-9727					GOLD FLASH	
87715-9728					15 MICROINCH	2.30
87715-9730					GOLD FLASH	
87715-9731					10 MICROINCH	2.54
87715-9732					15 MICROINCH	
87715-9733					GOLD FLASH	
87715-9734	164	NYLON46	GREEN (348C)	BRASS	10 MICROINCH	3.00
87715-9735					15 MICROINCH	
87715-9736					30 MICROINCH	2.54
87715-9737					GOLD FLASH	
87715-9738					15 MICROINCH	2.30
87715-9740					GOLD FLASH	
87715-9741					10 MICROINCH	2.54
87715-9742					15 MICROINCH	
87715-9743					GOLD FLASH	
87715-9744	164	NYLON46	PURPLE (2736U)	BRASS	10 MICROINCH	3.00
87715-9745					15 MICROINCH	
87715-9746					30 MICROINCH	2.54
87715-9747					GOLD FLASH	
87715-9748					15 MICROINCH	2.30

SEE SHEET 1 2008/10/17
 EC NO: SH2009-0199 2008/10/13
 T DRIVINGWANG08 2008/10/13
 CHKD:DMZHANG02 2008/10/17
 APPR:HWANG 2008/11/03

QUALITY SYMBOLS	DESCRIPTION
▽=0	
◻=0	

GENERAL TOLERANCES (UNLESS SPECIFIED)	
	mm INCH
4 PLACES	± --- ± ---
3 PLACES	± --- ± ---
2 PLACES	± 0.25 ± ---
1 PLACE	± 0.25 ± ---
ANGULAR ± 3 °	
DRAFT WHERE APPLICABLE MUST REMAIN WITHIN DIMENSIONS	

DIMENSION STYLE	
MM ONLY	
DRAWN BY	DATE
TOM	2004/07/20
CHECKED BY	DATE
ALLEN LIN	2004/07/20
APPROVED BY	DATE
WILSON	2004/07/20
MATERIAL NO.	
SEE TABLE	

SCALE	DESIGN UNITS	THIRD ANGLE PROJECTION
	METRIC	
TITLE		
PCI EXPRESS EDGE CARD CONNECTOR (LEAD FREE VERSION)		
MOLEX INCORPORATED		
DOCUMENT NO.	SHEET NO.	
SD-87715-207	11 OF 11	
THIS DRAWING CONTAINS INFORMATION THAT IS PROPRIETARY TO MOLEX INCORPORATED AND SHOULD NOT BE USED WITHOUT WRITTEN PERMISSION		

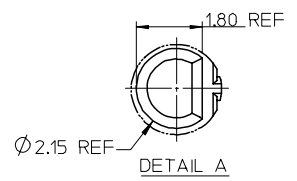
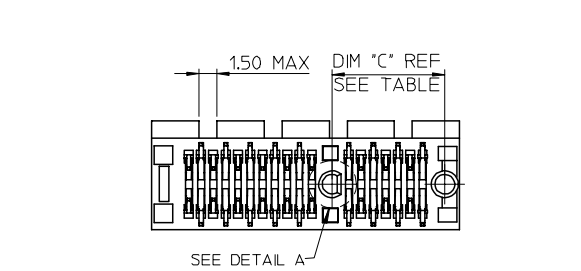
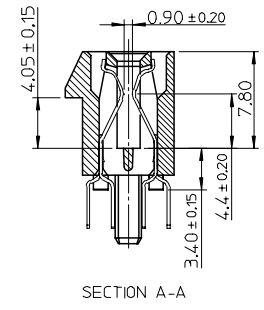
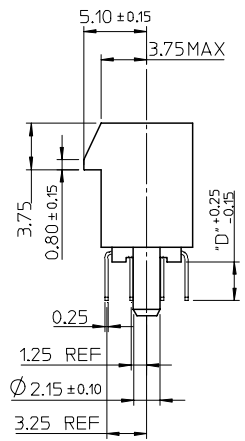
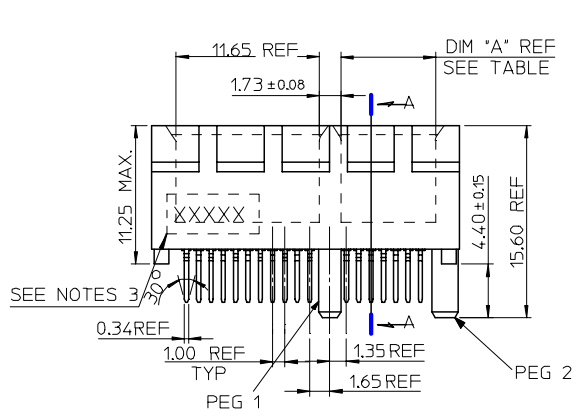
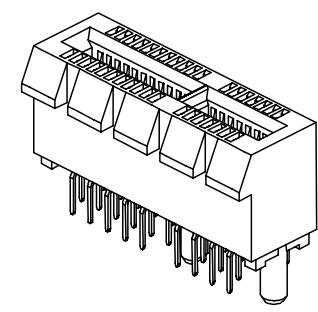
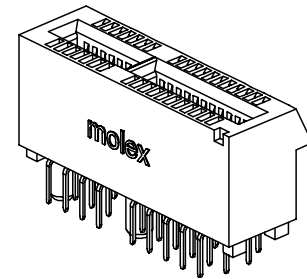
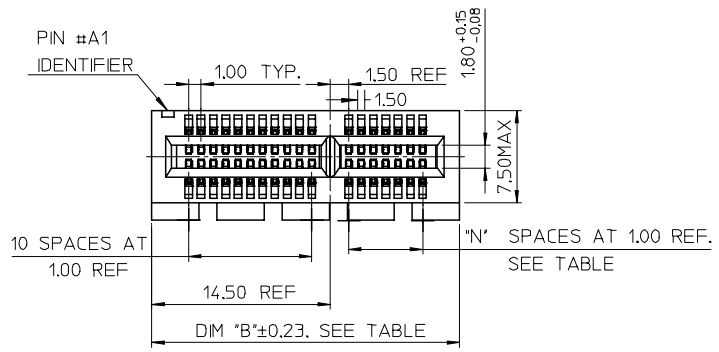

- NOTES:
- 1.MATERIALS:
 - 1-1.HOUSING: SEE TABLE ,GLASS FIBER FILLED UL94V-0, COLOR: SEE TABLE.
 - 1-2.CONTACT: SEE TABLE
 - 2.PLATING:
 - 2-1.CONTACT AREA: GOLD, THICKNESS : SEE TABLE .
 - 2-2.SOLDER TAIL: 100 MICRINCH MIN. TIN PLATING.
 - 2-3.UNDER PLATING: NICKEL PLATING OVERALL.
 - 3.DATE CODE: YY MM DD.
 - 4.PRODUCT SPECIFICATION REFER TO PS-87715-200.
 - 5.TEST SUMMARY:REFER TO TS-87715-207.

CONNECTOR LINK WIDTH	# POS REF	N	DIM 'A'	DIM 'B'	DIM 'C'
X1	36	6	7.65	25.00	9.15
X16	164	70	71.65	89.00	73.15

PCB THK (REF)	DIM 'D'
1.58	2.54
2.36	3.00

NEW RELEASE EC NO: SH2008-0170 DRWN:DRU CHKD:ROST ZHANG APPR:HWANG	2007/10/15 2007/10/15 2007/11/13	QUALITY SYMBOLS	GENERAL TOLERANCES (UNLESS SPECIFIED)	DIMENSION STYLE	SCALE	DESIGN UNITS	THIRD ANGLE PROJECTION
		▽=0 ▽=0	mm INCH	MM ONLY		METRIC	
			4 PLACES ± --- ± --- 3 PLACES ± --- ± --- 2 PLACES ± 0.25 ± --- 1 PLACE ± 0.25 ± --- ANGULAR ± 3 °	DRAWN BY DATE DAVID HU 2007/05/14 CHECKED BY DATE HARVEY 2007/05/14 APPROVED BY DATE JENNY CHEN 2007/05/14	TITLE PCI EXPRESS EDGE CARD CONNECTOR (LEAD FREE VERSION)		
			DRAFT WHERE APPLICABLE MUST REMAIN WITHIN DIMENSIONS	MATERIAL NO. SEE TABLE	DOCUMENT NO. SD-87715-901	SHEET NO. 1 OF 4	

10 9 8 7 6 5 4 3 2 1

F

E

D

C

B

A

F

E

D

C

B

A

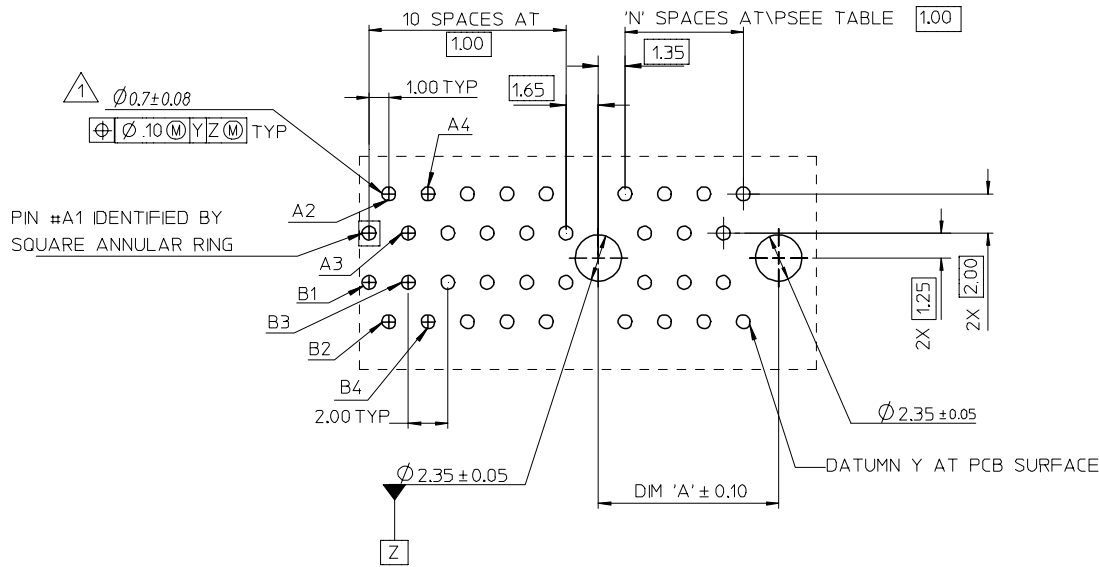

① THE HORIZONTAL AXIS FOR THE HOLE PATTERN IS ESTABLISHED BY A LINE THROUGH THE CENTER OF THE TWO $\varnothing 2.35$ HOLES. THE VERTICAL AXIS IS 90° TO THE HORIZONTAL AXIS, THROUGH THE CENTER OF DATUM Z

CONNECTOR LINK WIDTH	# POS REF	N	DIM 'A'
X1	36	6	9.15
X16	164	70	73.15

NEW RELEASE EC NO: SH2008-0170 DRWN:DRU CHK:AROST ZHANG APPR:HWANG	2007/10/15 2007/10/15 2007/11/13	DESCRIPTION REV	QUALITY SYMBOLS	GENERAL TOLERANCES (UNLESS SPECIFIED) mm INCH 4 PLACES ± --- ± --- 3 PLACES ± --- ± --- 2 PLACES ± 0.25 ± --- 1 PLACE ± 0.25 ± --- ANGULAR ± 3°	DIMENSION STYLE	SCALE	DESIGN UNITS	THIRD ANGLE PROJECTION		
					MM ONLY	METRIC				
				DRAWN BY DATE DAVID HU 2007/05/14		TITLE PCI EXPRESS EDGE CARD CONNECTOR (LEAD FREE VERSION)				
				CHECKED BY DATE HARVEY 2007/05/14						
				APPROVED BY DATE JENNY CHEN 2007/05/14		MOLEX INCORPORATED DOCUMENT NO. SD-87715-901 SHEET NO. 2 OF 4				
				MATERIAL NO. SEE TABLE						
				DRAFT WHERE APPLICABLE MUST REMAIN WITHIN DIMENSIONS		THIS DRAWING CONTAINS INFORMATION THAT IS PROPRIETARY TO MOLEX INCORPORATED AND SHOULD NOT BE USED WITHOUT WRITTEN PERMISSION				

9 8 7 6 5 4 3 2 1

10 9 8 7 6 5 4 3 2 1

F

E

D

C

B

A

F

E

D

C

B

A

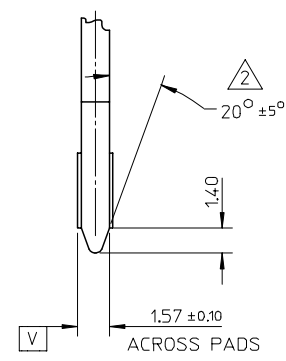
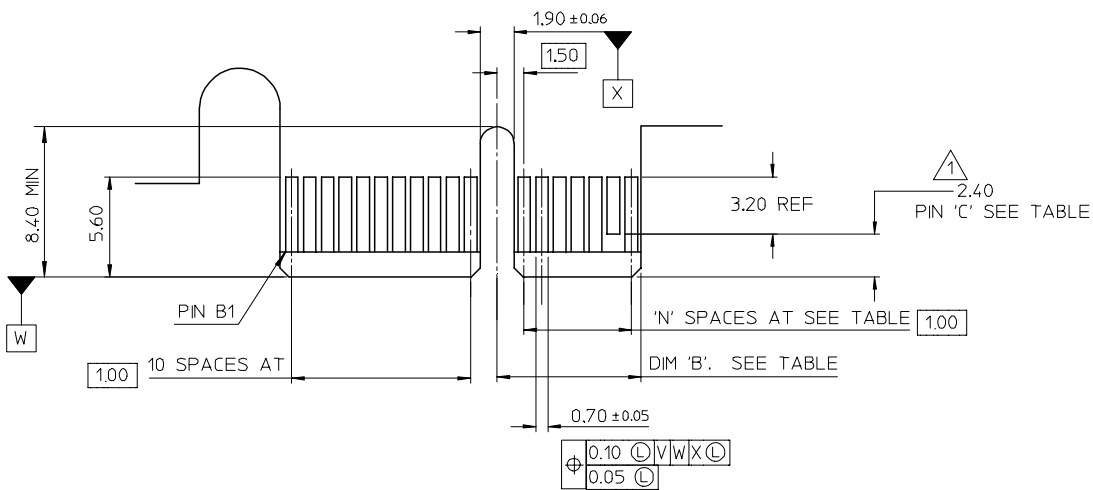

← I/O PANEL DIRECTION

PRIMARY (COMPONENT) SIDE

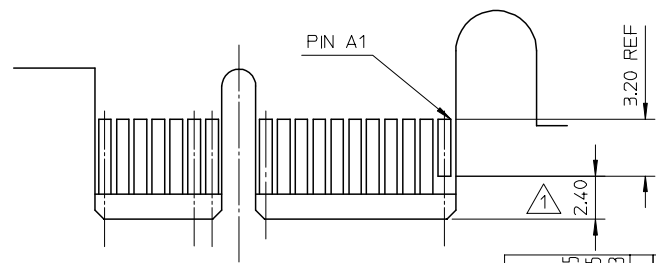

I/O PANEL DIRECTION →

SECONDARY (SOLDER) SIDE

- 1 NO TIE BAR PERMITTED FROM CARD EDGE TO LEADING EDGE OF PAD FOR PINS A1 AND "C".
- 2 CHAMFER EDGES MUST BE FREE OF CUTTING BURRS.
- 3 TOLERANCE: .XX±.13

CONNECTOR LINK WIDTH	# POS REF	N	DIM 'B'	'C' 1
X1	36	6	8.15	B17
X16	164	70	72.15	B17, B31 B48,B81

NEW RELEASE EC NO: SH2008-0170 DRWN:DRU CHK:AROST APPR:HWANG	2007/10/15 2007/10/15 2007/11/13	QUALITY SYMBOLS	GENERAL TOLERANCES (UNLESS SPECIFIED)	DIMENSION STYLE	SCALE	DESIGN UNITS	THIRD ANGLE PROJECTION
		▼=0 ▽=0	mm INCH 4 PLACES ± --- ± --- 3 PLACES ± --- ± --- 2 PLACES ± 0.25 ± --- 1 PLACE ± 0.25 ± --- ANGULAR ± 3 °	MM ONLY		METRIC	
		DESCRIPTION	DRAFT WHERE APPLICABLE MUST REMAIN WITHIN DIMENSIONS	DRAWN BY	DATE	TITLE	
		REV		DAVID HU	2007/05/14	PCI EXPRESS EDGE CARD CONNECTOR (LEAD FREE VERSION)	
				CHECKED BY	DATE	MOLEX INCORPORATED	
				HARVEY	2007/05/14	SHEET NO. 3 OF 4	
				APPROVED BY	DATE	DOCUMENT NO. SD-87715-901	
				JENNY CHEN	2007/05/14	MATERIAL NO.	
						SEE TABLE	
						THIS DRAWING CONTAINS INFORMATION THAT IS PROPRIETARY TO MOLEX INCORPORATED AND SHOULD NOT BE USED WITHOUT WRITTEN PERMISSION	

9 8 7 6 5 4 3 2 1

F

E

D

C

B

A

MOLEX P/N	CIRCUIT SIZE	HOUSING MATERIAL	HOUSING COLOR	TERMINAL MATERIAL	CONTACT PLATING	SOLDER TAIL 'D' LENGTH	PEG 1	PEG 2	DESCRIPTION
87715-9000					GOLD FLASH				
87715-9001					10 MICRONCH	2.54			
87715-9002					15 MICRONCH				
87715-9003					GOLD FLASH				
87715-9004	36	NYLON46	BLACK	PHOSPHOR BRONZE	10 MICRONCH	3.00			TOOLED
87715-9005					15 MICRONCH				
87715-9006					30 MICRONCH	2.54			
87715-9009					30 MICRONCH	3.00			
87715-9010					GOLD FLASH				
87715-9011					10 MICRONCH	2.54			
87715-9012					15 MICRONCH				
87715-9013					GOLD FLASH				
87715-6014	36	NYLON46	WHITE	PHOSPHOR BRONZE	10 MICRONCH	3.00			TOOLED
87715-9015					15 MICRONCH				
87715-9016					30 MICRONCH	2.54			
87715-9020					GOLD FLASH				
87715-9021					10 MICRONCH	2.54			
87715-9022					15 MICRONCH				
87715-9023					GOLD FLASH		WITH	WITH	UNTOOLED
87715-9024	36	NYLON46	BLUE (287U)	PHOSPHOR BRONZE	10 MICRONCH	3.00			
87715-9025					15 MICRONCH				
87715-9026					30 MICRONCH	2.54			
87715-9030					GOLD FLASH				
87715-9031					10 MICRONCH	2.54			
87715-9032					15 MICRONCH				
87715-9033					GOLD FLASH				
87715-9034	36	NYLON46	GREEN (348C)	PHOSPHOR BRONZE	10 MICRONCH	3.00			UNTOOLED
87715-9035					15 MICRONCH				
87715-9036					30 MICRONCH	2.54			
87715-9040					GOLD FLASH				
87715-9041					10 MICRONCH	2.54			
87715-9042					15 MICRONCH				
87715-9043					GOLD FLASH				
87715-9044	36	NYLON46	PURPLE (2736U)	PHOSPHOR BRONZE	10 MICRONCH	3.00			UNTOOLED
87715-9045					15 MICRONCH				
87715-9046					30 MICRONCH	2.54			
87715-0001			BLACK		15 MICRONCH			WITHOUT	TOOLED

MOLEX P/N	CIRCUIT SIZE	HOUSING MATERIAL	HOUSING COLOR	TERMINAL MATERIAL	CONTACT PLATING	SOLDER TAIL 'D' LENGTH	PEG 1	PEG 2	DESCRIPTION
87715-9300					GOLD FLASH				
87715-9301					10 MICRONCH	2.54			
87715-9302					15 MICRONCH				
87715-9303					GOLD FLASH				
87715-9304	164	NYLON46	BLACK	PHOSPHOR BRONZE	10 MICRONCH	3.00			TOOLED
87715-9305					15 MICRONCH				
87715-9306					30 MICRONCH	2.54			
87715-9309					30 MICRONCH	3.00			
87715-9310					GOLD FLASH				
87715-9311					10 MICRONCH	2.54			
87715-9312					15 MICRONCH				
87715-9313					GOLD FLASH				
87715-9314	164	NYLON46	WHITE	PHOSPHOR BRONZE	10 MICRONCH	3.00			TOOLED
87715-9315					15 MICRONCH				
87715-9316					30 MICRONCH	2.54			
87715-9320					GOLD FLASH				
87715-9321					10 MICRONCH	2.54			
87715-9322					15 MICRONCH				
87715-9323					GOLD FLASH		WITH	WITH	UNTOOLED
87715-9324	164	NYLON46	BLUE (287U)	PHOSPHOR BRONZE	10 MICRONCH	3.00			
87715-9325					15 MICRONCH				
87715-9326					30 MICRONCH	2.54			
87715-9330					GOLD FLASH				
87715-9331					10 MICRONCH	2.54			
87715-9332					15 MICRONCH				
87715-9333					GOLD FLASH				
87715-9334	164	NYLON46	GREEN (348C)	PHOSPHOR BRONZE	10 MICRONCH	3.00			UNTOOLED
87715-9335					15 MICRONCH				
87715-9336					30 MICRONCH	2.54			
87715-9340					GOLD FLASH				
87715-9341					10 MICRONCH	2.54			
87715-9342					15 MICRONCH				
87715-9343					GOLD FLASH				
87715-9344	164	NYLON46	PURPLE (2736U)	PHOSPHOR BRONZE	10 MICRONCH	3.00			UNTOOLED
87715-9345					15 MICRONCH				
87715-9346					30 MICRONCH	2.54			

NEW RELEASE EC NO: SH2008-0170 DRWN:DHU 2007/10/15 CHK:AROST ZHANG 2007/10/15 APPR:HWANG 2007/11/13	QUALITY SYMBOLS	GENERAL TOLERANCES (UNLESS SPECIFIED)	DIMENSION STYLE	SCALE	DESIGN UNITS	THIRD ANGLE PROJECTION	
	$\nabla = 0$ $\nabla \square = 0$	mm INCH 4 PLACES ± --- ± --- 3 PLACES ± --- ± --- 2 PLACES ± 0.25 ± --- 1 PLACE ± 0.25 ± --- ANGULAR ± 3 °	MM ONLY	DRAWN BY DATE DAVID HU 2007/05/14 CHECKED BY DATE HARVEY 2007/05/14 APPROVED BY DATE JENNY CHEN 2007/05/14		METRIC	PCI EXPRESS EDGE CARD CONNECTOR (LEAD FREE VERSION)
		DRAFT WHERE APPLICABLE MUST REMAIN WITHIN DIMENSIONS	SEE TABLE	MOLEX MOLEX INCORPORATED			
				MATERIAL NO.	DOCUMENT NO.	SHEET NO.	
				SD-87715-901	4 OF 4		